



UNIT  
**12**

# **U.S. PUBLIC LAND SURVEY SYSTEM**

**Jim McCavitt, PLS  
Bureau of Land Management**

## **Introduction**

The United States Public Land Survey System (PLSS) began with the Land Ordinance of 1785. The ordinance provided for the systematic survey and monumentation of the federal lands into townships and sections. The system was largely put in place by 1805, with only minor refinements being made from time to time thereafter. The surveys in California were initiated in 1851, shortly after statehood.

The intent of the system was to survey and monument the western lands prior to patenting the lands to private citizens. The surveyed sections provided standard sized and shaped parcels of land, interrelated by reference to townships and initial points. Simple aliquot part descriptions, dividing sections into halves and fourths *ad infinitum*, were all that were necessary to describe with certainty a parcel of land.

The survey plats furnish the basic data relating to the survey and description of all areas within the particular township. All title records within the area of the former public domain are based on a government grant or patent, with the description referenced to the official plat. The plats are developed from the field notes, which are the written descriptive record of the survey. The survey plats and field notes are essential in determining the limits of PLSS parcels.

The effects of curvature and convergency on large scale surveys, such as the PLSS, can be dramatic. The PLSS has limited the effects of convergency with the use of standard parallels (or correction lines) at certain intervals. Several methods are available to correct for the effects of the curvature of lines.

The responsibility for the survey of federal lands currently rests with the Bureau of Land Management (BLM), which is the successor to the General Land Office (GLO). The *Manual of Surveying Instructions* (hereafter referred to as Manual) is issued by the BLM (and previously by the GLO) as a guide for BLM surveyors. The Manual describes how the public land surveys are made in conformance to statutory law and its judicial interpretation. The current edition of the Manual was issued in 1973. Previous editions of the Manual were issued in 1855, 1871, 1881, 1890, 1894, 1902, 1930 and 1947. The lines of a survey are established in accordance with the Manual in force on the date of the survey.

Understanding the PLSS framework of lines and corners is necessary for success on the land surveyor exams. The basic framework of PLSS lines consists of principal meridians, base lines, standard parallels, guide meridians, township lines and section lines. The corners established by the original surveys include standard, township, section, quarter-section, closing, and witness corners. It is important to know the significance of each PLSS line and corner in the scheme of the system.

Parcels of land in the PLSS, which cannot be described as aliquot parts of sections, are designated as lots or tracts. Lots are ordinarily located within a section. Tracts generally encompass an area in a township, lying in more than one section. The most common example of lots are along the north and west boundaries of a township, where the excess or deficiency in measurement was placed.

Sections ordinarily were not subdivided on the ground in the original surveys. The original survey plats show the plan and controlling measurements for the section subdivision survey. This plan may be superseded by supplemental or resurvey plats. Section subdivision surveys range from relatively simple divisions of regular sections into quarters to more complex situations involving fractional sections or arduous parenthetical distance determinations. To properly subdivide a section, it is important to be able to recognize unique situations and then apply the appropriate procedures.

As a professional land surveyor, any work you do on the PLSS will invariably involve dependently resurveying township or section lines. A dependent resurvey is first a retracement to identify original corners and other acceptable points of control. Second, it restores lost corners by proportionate measurement in accordance with the record of the original survey. The distinctions between existent corners, obliterated corners, and lost corners must be understood. An important point to remember is that the boundaries of sections based on an original survey are identical to the boundaries of the same sections based on a properly executed dependent resurvey.

To reestablish a lost corner position, it is important to know how restoration procedures are computed. Even more important, the professional surveyor must know how and when to use the various restoration procedures. The rules for the restoration of lost corners should not be applied until all original and collateral evidence has been developed and analyzed.

The PLSS topics and procedures discussed in the video, combined with this workbook, should provide a good foundation for the land surveyor examinations. Surveyors should not rely solely on this course in the PLSS studies for the exam. The pertinent portions of the 1973 Manual, such as Chapters 5 and 6, should be read and understood, along with other advised readings.

## **Performance Expected on the Exams**

Given a survey plat, identify PLSS lines as to type.

Given a survey plat, identify the various PLSS corners and aliquot parts shown.

Explain the survey procedures necessary to subdivide a regular section or a fractional section.

Given a northerly or westerly section in a township, determine the parenthetical distances necessary to subdivide a section.

State the types of evidence that are acceptable for the restoration of an obliterated PLSS corner.

Choose the appropriate restoration procedure for a lost corner and compute the position to reestablish the corner.

## Key Terms

- Aliquot part
- Patent
- Parenthetical distance
- Lot
- Corner
- Tract
- Monument
- Bearing tree
- Existent corner
- Standard parallel
- Obliterated corner
- Township
- Lost corner
- Section
- Retracement
- Meander corners
- Dependent resurvey
- Meander line
- Standard corner
- Subdivision of sections
- Closing corner
- Protraction
- Witness corner
- Proportionate measurement

## Video Presentation Outline

### History and Research

- Importance of Manual in effect at time of survey
- Availability of plats and notes

### PLSS Datum

- Distance
- Direction
- Latitudinal lines (curved lines)

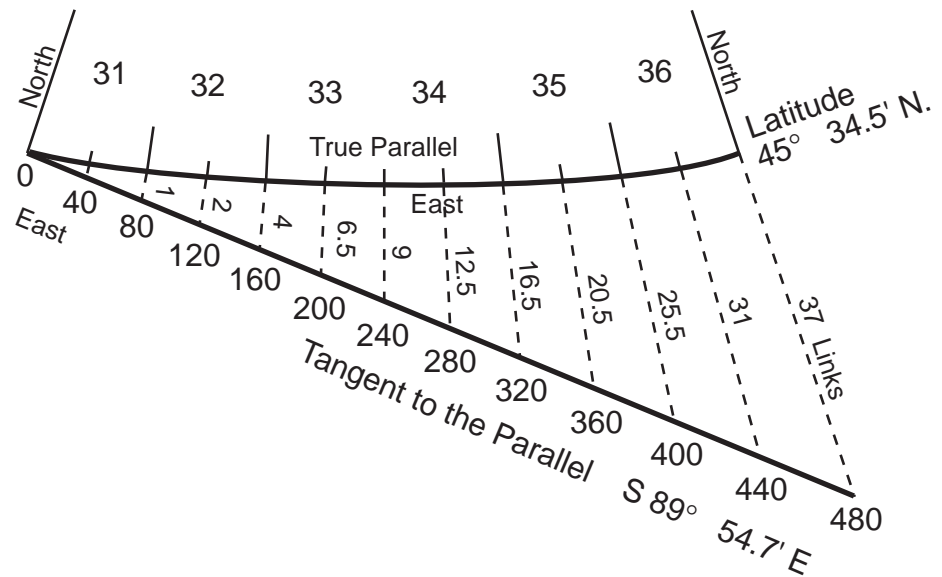

**Figure 12-1.** Offsets to curved line of latitude.

### PLSS Framework

- Initial points
- Principal meridians and base lines
- Meridional lines and convergence

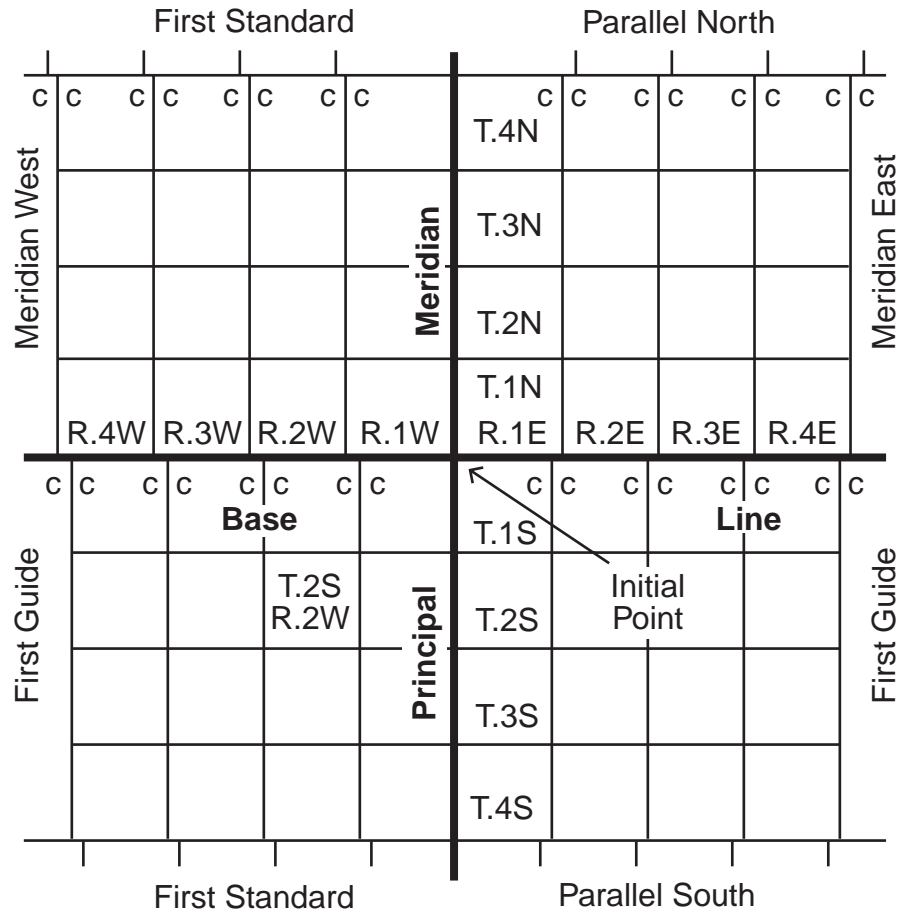

Figure 12-2. The PLSS framework.

- Township exteriors
- Subdivision of townships
- Differences between Manuals of 1851 and 1855
- Meander lines
- Monumentation

6	5	4	3	2	1
7	8	9	10	11	12
18	17	16	15	14	13
19	20	21	22	23	24
30	29	28	27	26	25
31	32	33	34	35	36

*Figure 12-3. Typical township.*

- Protracted subdivision of sections
- Aliquot parts

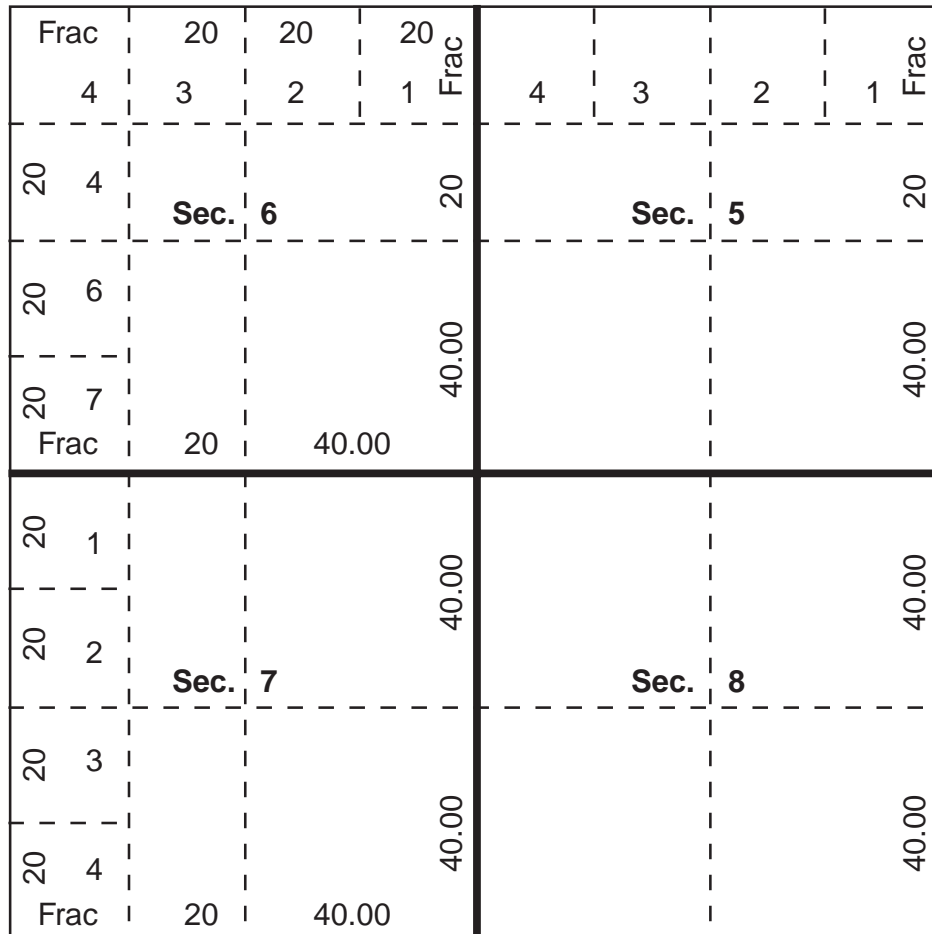

Figure 12-4. Normal protracted subdivision of sections.

### Subdivision of Sections

- Center quarter-corner
- One sixteenth corners
- Parenthetical distances



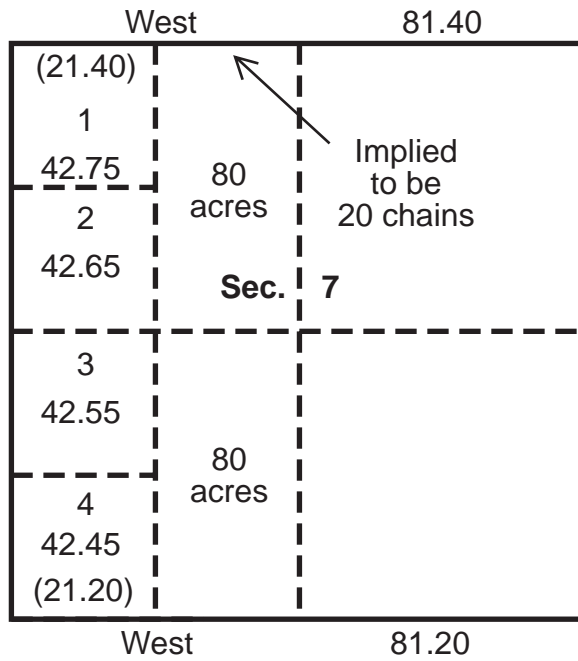

Figure 12-5. Parenthetical distances, west tier of township.

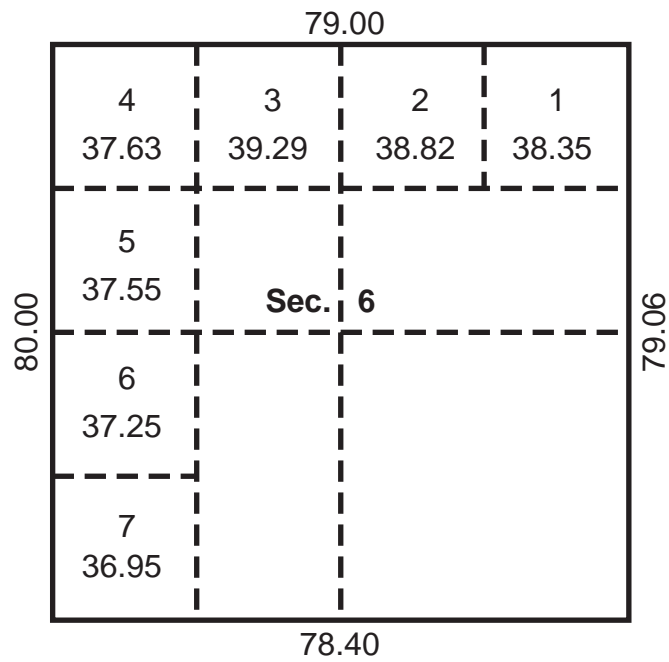

Figure 12-6. Parenthetical distances, Section 6.

### Subdivision of Fractional Sections

- Running lines parallel to established courses
- Running lines on mean courses

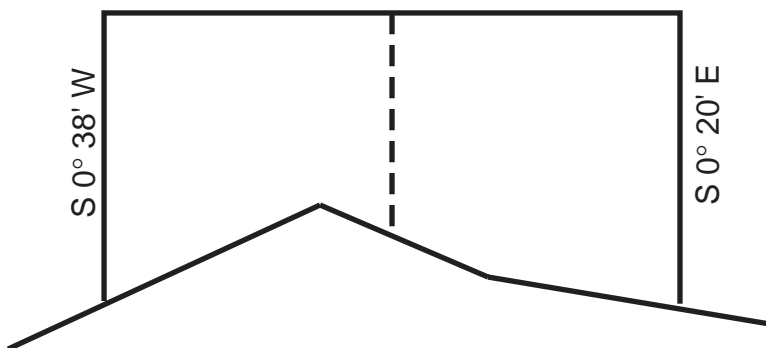

Figure 12-7. Arithmetic mean.

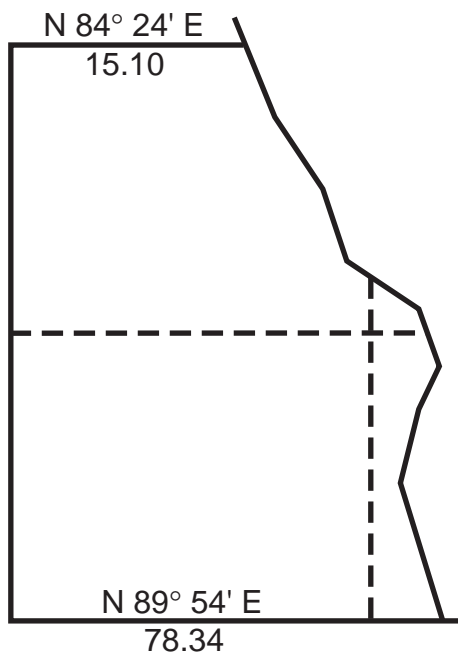
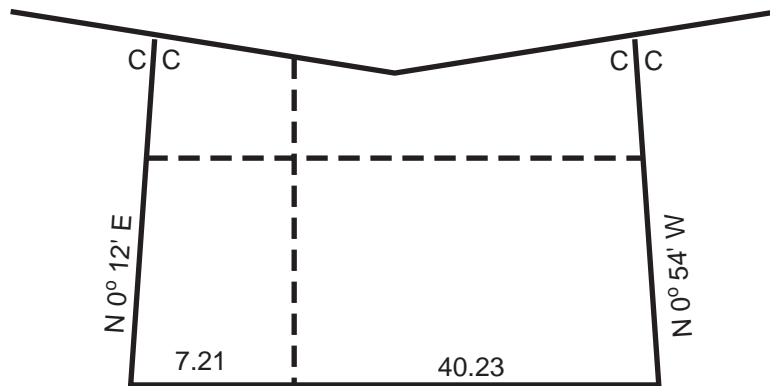

Figure 12-8. Weighted mean.



*Figure 12-9. Weighted mean of uncentered centerline.*

### **Dependent Resurveys**

- Definitions
  - Monument
  - Corner
  - Existent corner
  - Obliterated corner
  - Lost corner
- Independent resurveys
- Topographic calls

### **Restoration of Lost Corners**

- Proportionate measure
- Precedence of lines and corners
- Double proportion

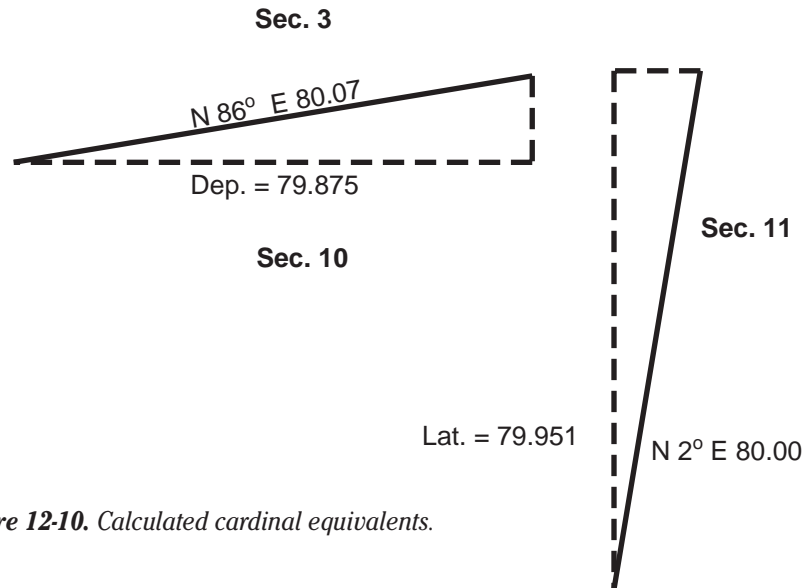

Figure 12-10. Calculated cardinal equivalents.

### Calculating Coordinates

Calculate coordinates for restored corner. All dimensions are in chains, coordinates shown are per retracement.

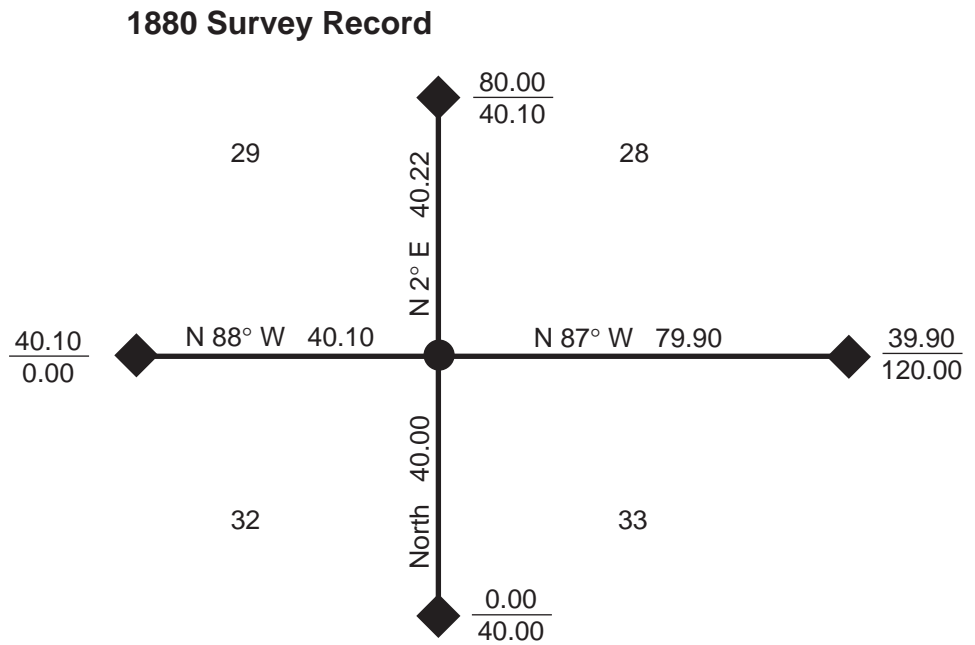
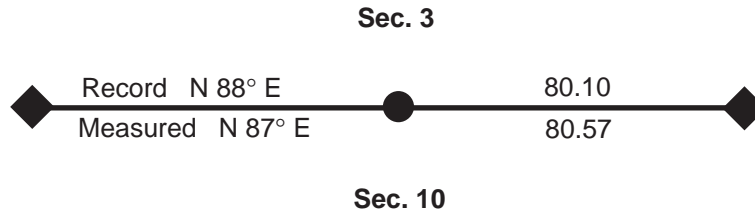

Figure 12-11. Found monuments, record, and field.

Calculate coordinates for restored corner. All dimensions are in chains.

- Single Proportion



**Figure 12-12.** Single proportion, record, and measured distances.

- Proportionate measure along irregular boundaries
- 3-point control
- 2-point control
- 1-point control
- Meander corners
- Closing corners

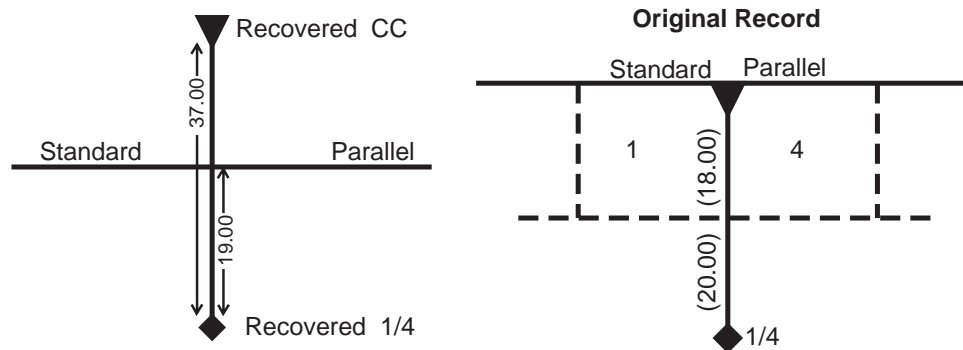

**Figure 12-13.** Reset closing corner.

- Witness corners as controlling monuments
- Line trees
- Double sets of corners

## Example Problems

### Problem A-5 1991 LS

You have been commissioned to survey fractional Section 8, T4S, R6W as shown on the official plat, which was approved on April 3, 1893. Your client has requested that all corners be monumented.

Required:

1. Identify the method and the positions and/or monuments you would hold for control to establish each of the corners denoted as "a" through "f" below. No calculations are required.
  - A. Southwesterly section corner
  - B. Northwesterly corner of government Lot 2
  - C. North corner common to government Lots 1 and 2
  - D. Northeastery corner of government Lot 1
  - E. East quarter-corner
  - F. Center quarter-corner
2. Cite the governing reference that verifies the method of establishing the corners.
3. Calculate the coordinates for the southwesterly corner of Section 8. Show all work.

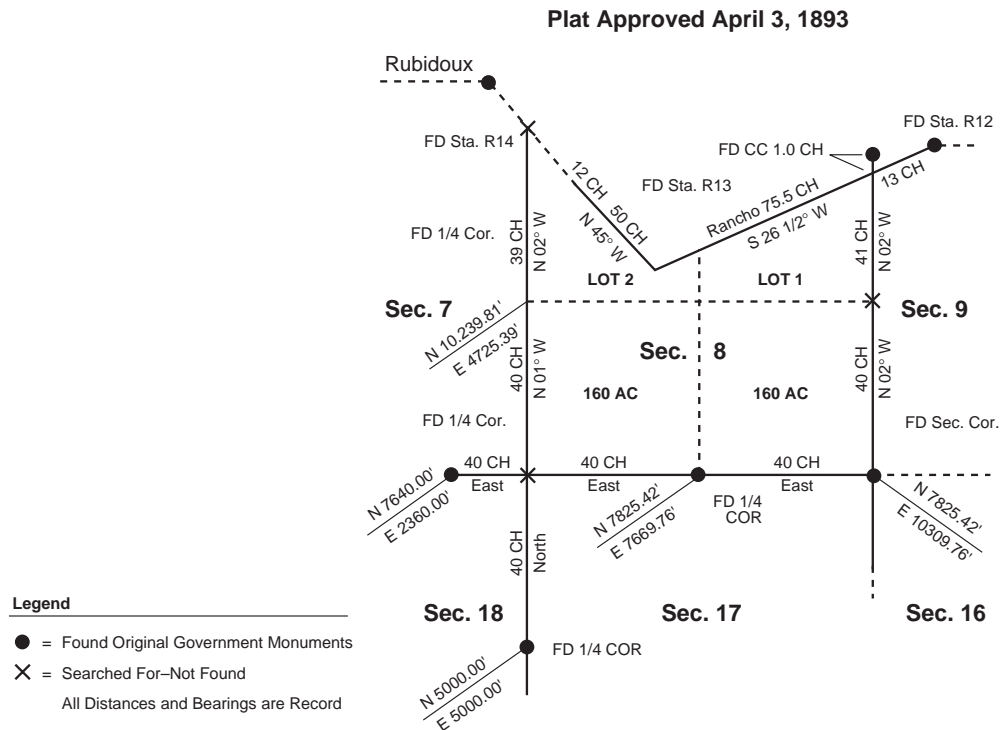

### Problem A-1 1990 LS

Rancho Leonardo is shown in part on the plat dated 1860 below. The rancho follows sectional lines.

Required:

Using the coordinates indicated on the survey plat shown, calculate the bearings and distances of the rancho lines denoted as A, B, and C in Section 14. Show your answers directly on the survey plat. On the grid paper provided, identify your methods and show all your work.

Portion of 1860 Plat

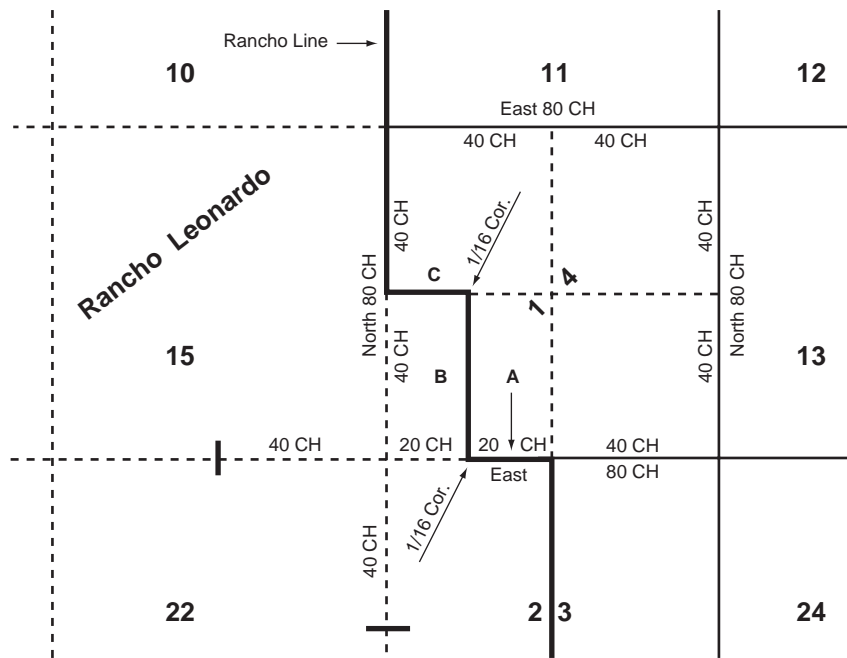

**Legend**

CH = Chains

Basis of Bearings Based on Solar Observation

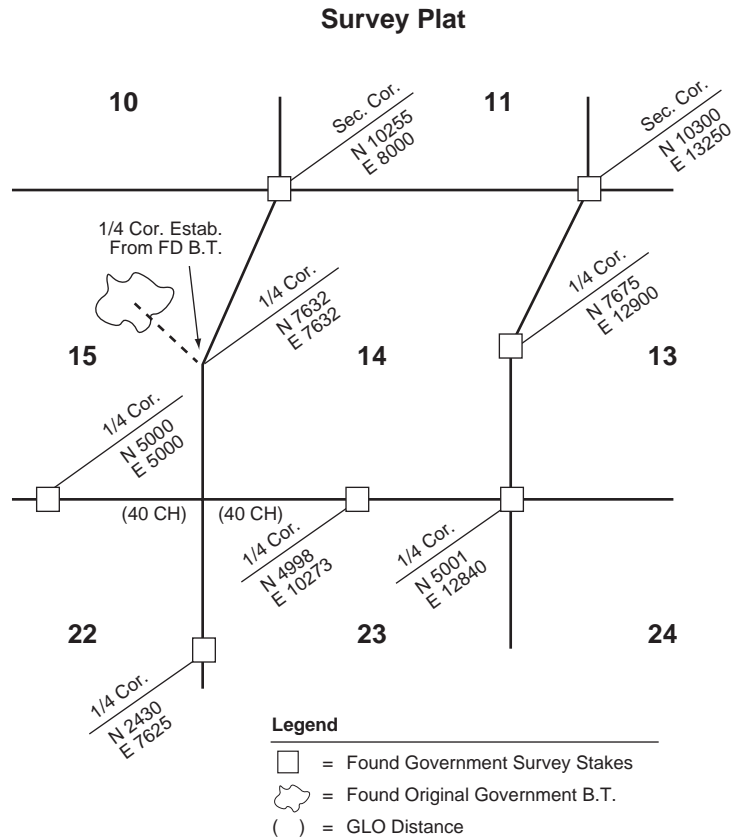

Solution:

Double proportion the southwest corner of Section 14:

$$\text{Northing of proportioned position: } \left(\frac{40}{80}\right) (7632 - 2430) + 2430 = 5031$$

$$\text{Easting of proportioned position: } \left(\frac{40}{80}\right) (10273 - 5000) + 5000 = 7636.50$$

Single proportion the north quarter-corner of Section 14

$$\text{Northing of proportioned position: } \frac{(10300 - 10255)}{2} + 10255 = 10277.5$$

$$\text{Easting of proportioned position: } \frac{(13250 - 8000)}{2} + 8000 = 10625$$



Establish center quarter of section by intersecting the lines between opposite quarter-corners:

N 7655.01; E 10450.15

Position of west 1/16 corner:

$$\text{Northing} = \frac{(5031 - 4998)}{2} + 4998 = 5014.5$$

$$\text{Easting} = \frac{(10273 - 7636.5)}{2} + 7636.5 = 8954.75$$

Position of center west 1/16 corner:

$$\text{Northing} = \frac{(7655.01 - 7632)}{2} + 7632 = 7643.50$$

$$\text{Easting} = \frac{(10450.15 - 7632)}{2} + 7632 = 9041.08$$

Dimensions by inverse:

- A. N 89° 16' 58" W      1318.35'
- B. N 01° 52' 51" E      2630.42'
- C. S 89° 31' 7" W      1409.13'

**Problem B-3 1990 LS**

Below is a sketch compiled from GLO plat and field notes dated July 26, 1879.

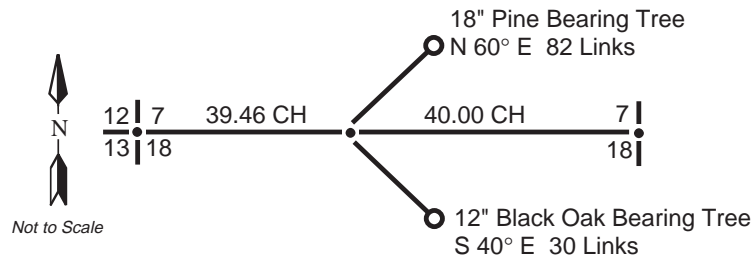

Below is a sketch showing the results of a field survey performed in January 1990.

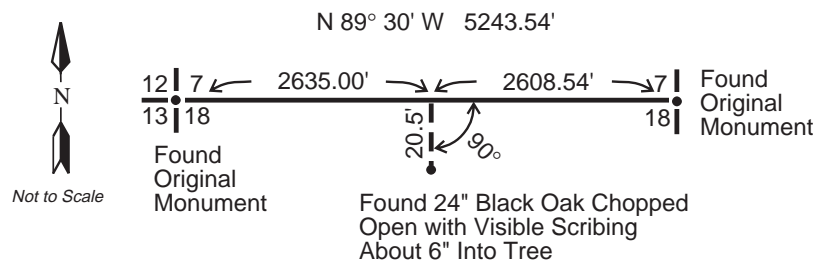

Required:

1. Describe how you would re-establish the missing quarter-corner monument position.
2. Assume that, in addition to the oak tree, you had found a blazed 18 in living pine tree without visible scribing near the location called in the notes for the 18 in pine bearing tree. How would you re-establish the missing quarter-corner monument position? Explain your answer.

# Sample Test Questions

## 1. Problem A-4 1988 LS

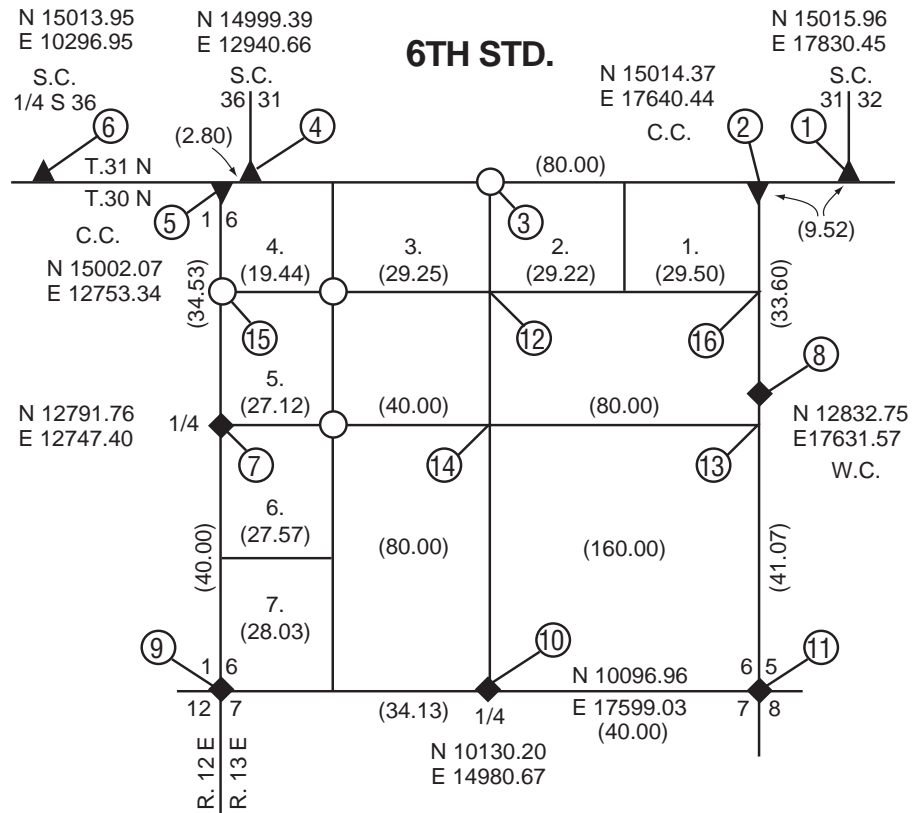

### Legend

- ▲ or ◆ Indicates Found Corner
- Indicates Corner to be Set
- ( ) Empraces GLO Data  
Coordinates are From Your Field Survey

NOTE: All found corners are accepted

Required:

Based on the previous diagram, answer the following multiple choice questions, A through I, by selecting the answer you believe to be correct from the choices given as indicated by the letters a, b, c, and d. (Circle the correct answers.)

- A. What is the record length of the north line of Section 6, T 30 N, R 13 E?
1. 92.32 chs
  2. 73.28 chs
  3. 80.00 chs
  4. 67.68 chs
- B. How would you establish the northeast corner of Section 6, T 30 N, R 13 E?
1. Accept the found monument, as it is an original corner.
  2. On line between Pt. 1 and Pt. 4, holding the distance of 9.52 chs from Pt. 1.
  3. At the intersection of the line between Pt. 8 and Pt. 2 and the standard parallel.
  4. On the standard parallel at the proportionate distance from Pt. 1.
- C. How would you establish the north quarter-corner of Section 6, T 30 N, R 13 E?
1. Midway between Pt. 2 and Pt. 5.
  2. On the standard parallel 40 chs from Pt. 2.
  3. On the standard parallel and 40.42 chs from the northeast corner of Section 6.
  4. On the standard parallel and 36.64 chs from the northeast corner of Section 6.
- D. How would you establish the northwest corner of Section 6, T 30 N, R 13 E?
1. On line between Pt. 5 and Pt. 7 at 34.53 chs from Pt. 7.
  2. On line between Pt. 4 and Pt. 6 at 2.80 chs from Pt. 4.
  3. Accept the found monument, as it is an original corner.
  4. None of the above.
- E. The record length of the north line of Lot 4, Section 6, T 30 N, R 13 E is?
1. 20.00 chs
  2. 19.44 chs
  3. 17.2 chs
  4. 13.28 chs
- F. The record length of the west line of Lot 4, Section 6, T 30 N, R 13 E is?
1. 17.26
  2. 14.53 chs
  3. 20.00 chs
  4. 19.44 chs

- G. What are the record dimensions of Lot 7, Section 6, T 30 N, R 13 E?
1. 20 chs on all sides.
  2. East and west lines 20 chs; north and south lines 17.06 chs.
  3. East and west lines 20 chs; south line is 14.13 chs; north line is 13.90 chs.
  4. East and west lines 20 chs; north and south lines 14.13 chs.
- H. How would you establish the northwest corner of the southwest quarter of the northeast quarter of Section 6, 30 N, R 13 E?
1. Single proportion between Pt. 14 and Pt. 3.
  2. At the intersection of lines 15-16 and 14-3.
  3. On line between Pt. 14 and Pt. 3 and 20 chs from Pt. 3.
  4. Single proportion between Pt. 15 and Pt. 16.
- I. What are the ground coordinates of the east quarter-corner of Section 6, T 30 N, R 13 E as you would establish it based on measured values?
1. N 12762.13; E 17630.73
  2. N 12832.75; E 17631.57
  3. N 12761.47; E 17630.72
  4. None of the above.

**2. Problem A-3 1989 LS**

The portion of a township plat shown below has been annotated to show which corners are lost and found at this date. Township 4 North, Range 2 East is bounded by regularly surveyed townships to the west, north and east, and by Rancho Rivetta to the south.

The found original corners are U.S. Government Survey monuments described in the notes of the survey. There are no topographical or accessory calls recovered; the lost original corners have been properly identified as such.

No excessive distortion was found in the record dimensions indicated in the plat and field notes for the rancho and township.

**Exhibit Plat**

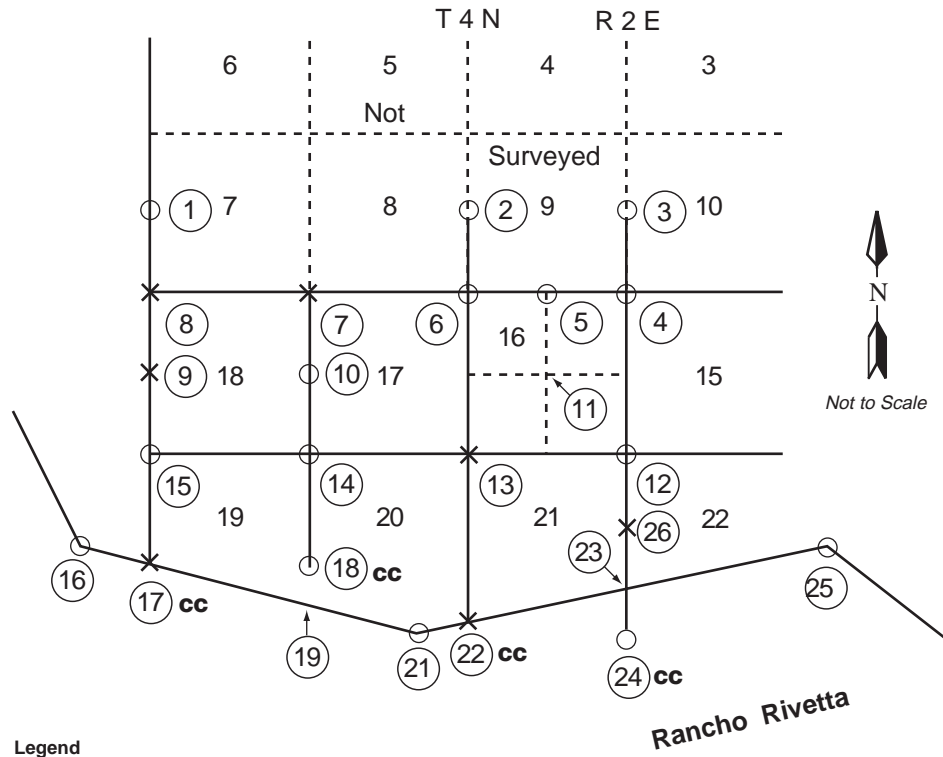

**Legend**

- = Found Original Corner, Numbered as Indicated
- × = Lost Original Corner
- cc** = Closing Corners

**Required:**

- A. Explain the procedure necessary to establish the corners in the following order: 8, 9, 17, 19, 23, 22, 26, 13, 11, 7.
- B. As a licensed land surveyor, what would you be required to file to show the monumentation of:
  1. Corner 11
  2. Corner 5
- C. Describe or cite the definition of:
  1. A lost corner
  2. An obliterated corner

3. Your client has asked you to monument the west line of his property. The property is described as “the east one-half of Lot 2, Section 3, Township 33 North, Range 3 East, Mt. Diablo Meridian, as shown on the GLO plat dated March 5, 1888.” How would you set the corners?
4. You are to set the southwest corner of Section 34 which is lost. The sketch shows the record dimensions per GLO. The south boundary of the township along Section 34 was surveyed in 1863. The completion survey of the south boundary of the township was completed in 1879 (random and true line) giving the record bearing and distance for the south line of Section 33 as shown. Coordinates shown are per your field survey. What are the coordinates of the southwest corner of Section 34?

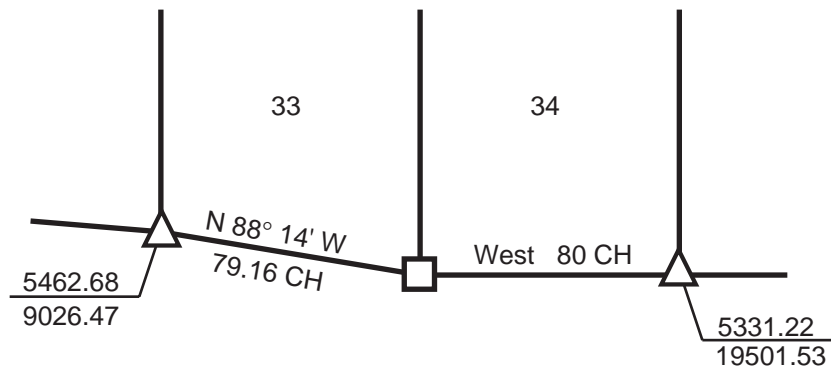

5. If you find a record closing corner and set a new monument at its true position on the line closed upon, what, if anything, should be done to the original closing corner? What are your responsibilities according to the Land Surveyors Act?

6. Record GLO dimensions and coordinate values for field tied existent corners are shown on the sketch. The coordinates shown are for a local coordinate system based on the true meridian. What are the coordinates of the restored section corner common to Sections 14, 15, 22 and 23?

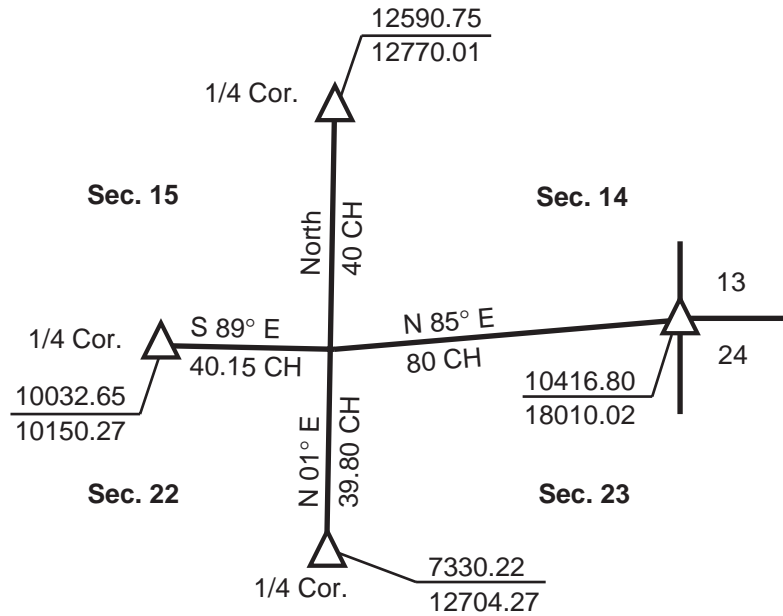

7. If the existent corners in problem 6 were tied from CCS control, how would the proportioning be carried out to ensure correct values to reestablish the corner of Sections 14, 15, 22 and 23?



## Answer Key

1.
  - A. 2.
  - B. 3.
  - C. 3.
  - D. 4.
  - E. 4.
  - F. 2.
  - G. 3.
  - H. 2.
  - I. 4.
  
2.
  - A. **Corner 8** is reestablished by single proportionate measurement between corners 1 and 15 (5:30 and 5:25).  
**Corner 9** is reestablished by single proportionate measurement between corners 1 and 15 (5:30).  
**Corner 17** is established by single proportionate measurement between corners 16 and 21 (5:41).  
**Corner 19** is established at the intersection of a line run southerly from corner 14 through corner 18, with the line between corner 16 and corner 21 (5:41).  
**Corner 23** is established at the intersection of the line between corners 12 and 24, and the line between corners 21 and 25 (5:41).  
**Corner 22** is established by single proportionate measurement between corners 21 and 25 (5:41).  
**Corner 26** is reestablished on line at a proportionate measurement between corners 12 and 24 (5:41).  
**Corner 13** is established by double proportionate measurement between corners 12 and 14, and corners 22 and 6 (5:29).  
**Corner 11:** The lost exterior quarter-corners of Section 16 are first reestablished by single proportioning between corners 6 and 13, 12 and 13, and 12 and 4. Corner 11 is then established by intersecting straight lines between opposite corresponding quarter-corners (3:87).  
**Corner 7:** The position in departure is determined by single proportioning between corners 6 and 8. (The record bearings for the north boundaries of Sections 17 and 18 may be different; if so, it may be necessary to use cardinal equivalents.) The position in latitude is determined at the record latitudinal distances from corner 10 (5:29).
  - B. **Corner 11:** Record of Survey (8773A).  
**Corner 5:** Record of Survey or corner record (8773A).

C. “A lost corner is a point of a survey whose position cannot be determined, beyond reasonable doubt, either from traces of the original marks or from acceptable evidence or testimony that bears upon the original position, and whose location can be restored only by reference to one or more interdependent corners” (5:20).

“An obliterated corner is one at whose point there are no remaining traces of the monument or its accessories, but whose location has been perpetuated, or the point for which, may be recovered beyond reasonable doubt by the acts and testimony of the interested landowners, competent surveyors, other qualified local authorities, or witnesses, or by some acceptable record evidence” (5:19).

References are to *Professional Land Surveyors Act/Board Rules and Manual of Instructions*, 1973.

3. Federal rules would apply in this case because of the reference to the GLO plat. The west line is the line between the midpoints of the north and south lines of the lot.

4. Cardinal equivalent departure for south line Section 33:

$$\cos 1^\circ 46' \times 79.16 \text{ ch} = 79.1224 \text{ ch}$$

Proportional departure along south line of Section 34:

$$\frac{80 \text{ ch}}{159.1224 \text{ ch}} = \frac{d}{10,475.06 \text{ ft}}$$

$$d = 5266.423 \text{ ft}$$

Easting of southwest corner of Section 34:

$$19501.53 - 5266.42 = 14,235.11$$

Cardinal equivalent of record latitude:

$$\sin 1^\circ 46' \times 79.16 \text{ ch} = 2.4404 \text{ ch}$$

Difference in latitude from field to record:

$$131.46 \text{ ft} - 2.4404 (66) = -29.61 \text{ ft}$$

Proportion difference in latitude for south line Section 34:

$$\frac{80 \text{ ch}}{159.16 \text{ ch}} = \frac{d}{-29.61}$$

$$L = -14.88 \text{ ft}$$

Northing of southwest corner of Section 34:

$$5331.22 - 14.88 = 5316.34$$

5. The original closing corner should be marked “AM.” A Corner Record must be filed unless the new closing corner will be shown on a record map (Record of Survey, Parcel Map or Final Map).

6. Record cardinal equivalent departure from south quarter of Section 15 to lost corner:

$$\sin 89^\circ (40.15) = 40.1439 \text{ ch}$$

Record cardinal equivalent departure from lost corner to the southeast corner of Section 14:

$$\sin 85^\circ (80) = 79.6956 \text{ ch}$$

Departure from south quarter-corner of Section 15 to proportioned position of lost corner:

$$\frac{40.1439 \text{ ch}}{119.8395 \text{ ch}} = \frac{d}{7859.75 \text{ ft}}$$

$$d = 2632.86$$

Easting of proportioned position:

$$10150.27 + 2632.86 = 12783.13$$

Record of cardinal equivalent latitude from west quarter-corner of Section 23 to lost corner:

$$\cos 01^\circ (39.80) = 39.7939 \text{ ch}$$

Latitude from west quarter-corner Section 23 to proportioned position of lost corner:

$$\frac{39.7939 \text{ ch}}{79.7939 \text{ ch}} = \frac{L}{5260.53}$$

$$L = 2623.47 \text{ ft}$$

Northing of proportioned position:

$$7330.22 + 2623.47 = 9953.69 \text{ ft}$$

7. Before the latitudes and departures can be proportioned, the field ties and record information must be on the same basis of bearings. In this case field ties are based on the California Coordinate System and the original record information is astronomic. Cardinal equivalent (astronomic) latitudes and departures will differ from the latitudes and departures based on CCS grid north.

One way to ensure correct values is to rotate the grid bearings to an astronomic basis and then proceed to proportion the cardinal equivalent latitudes and departures. After the proportioning is complete and bearings and distances have been computed to the reestablished corner, the bearings can be rotated back to a grid basis.

## References

- \_\_\_\_\_, *Manual of Instructions for the Survey of the Public Lands of the United States*, Bureau of Land Management, 1973.
- \_\_\_\_\_, *Restoration of Lost or Obliterated Corners & Subdivision of Sections*, Bureau of Land Management, 1974.
- Brown, Curtis, *Boundary Control and Legal Principles*, Third Edition, John Wiley & Sons, New York, 1988.
- Robillard and Bouman, *Clark on Surveying and Boundaries*, Fifth Edition, Michie Co., Charlottesville, VA.
- White, C. Albert, *A History of the Rectangular Survey System*, U.S. Government Printing Office, Washington, D.C. 20402, Stock Number 024-011-00150-6.